

VISTA 5.0M SQUARE CANTILEVER

STYLES AVAILABLE

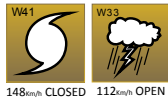

WIND RATING



FRAME MATERIAL



COLUMN TYPE



FEATURES



PRICE



V50S DIMENSIONS

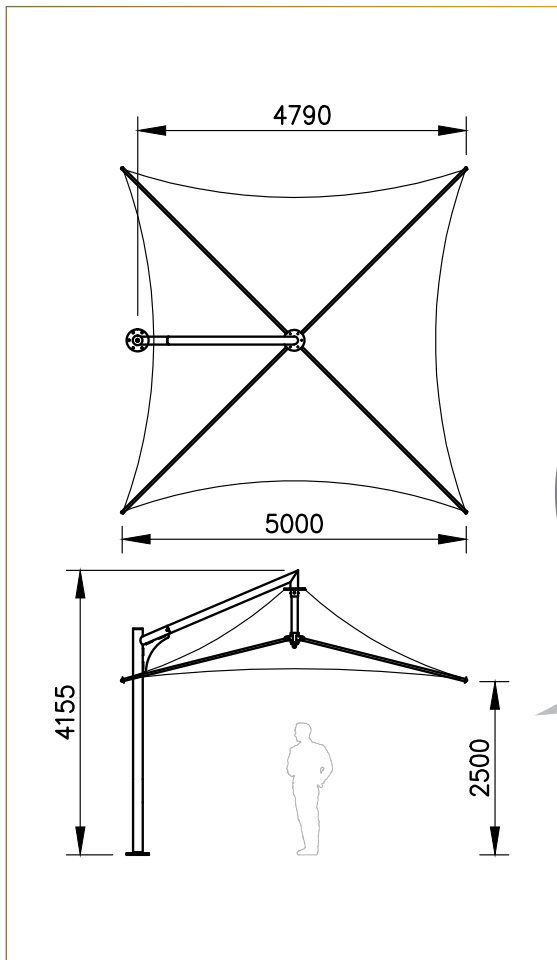

The Vista range has a cantilevered frame ideal for pools, cafes and public spaces where clear space under the canopy is preferred. The optional 360 degree pivoting base is perfect for utilising the shade at varying times of the day or for covering more than one area.

- Available in square, hexagonal and rectangular shapes.
- 2.4m – 5.6m standard sizing.
- Proprietary concealed winding mechanism allows for quick retracting in extreme weather.
- Made from a hot dipped galvanised structural steel, powder coated to any Dulux/Interpon colour.
- Low maintenance, translucent, heat reflective, UV treated and fully welded architectural grade PVC membrane available in a large variety of colours.
- Marine grade stainless steel catenary cable and fittings.
- 5 year structural warranty on the frame & 2 year warranty on the canopy.
- Engineer wind rated to 112 kph (W33) open & 148 kph (W41) closed.
- Accessory options include 360 degree pivot base, PVC curtains, rain diverters, link panels (joining umbrellas), corporate branding, down/up lights, heaters and speaker systems.



4M VISTA HEXAGONAL CANTILEVER UMBRELLAS



VISTA 4M SQUARE UMBRELLAS WITH INTERNAL FRAME OPTION